



Engineered by



PRECISION  
SURFACING  
SOLUTIONS

# ISO G 11



# OVERVIEW



# UNIVERSAL TOOL GRINDING



## EFFICIENT GRINDING

The ISOG 11 was specially designed for grinding precision tools. With the ISOG 11 single tools and small batches can be ground fast, economically and flexibly – and all this with high ease of use. The ISOG 11 even masters most complex, demanding and highly precise tools with brilliant performance.

- ⊕ Patented T-shaped design for easy one-sided operation
- ⊕ Precise, smooth-running movements
- ⊕ Measuring and monitoring in the machine using video technology
- ⊕ Adjustable zoom lens (25 to 170x)
- ⊕ Motor-driven height and fine adjustment for larger grinding range, high radial runout accuracy and high ease of use
- ⊕ Infinitely variable spindle drive



## A PERFECT BASIS

The ISOG 11 is already equipped with substantial extras in the basic version, in an abundance and with a practicality that you will only find with the ISOG 11. And with good reason: We want you to be enthusiastic about the performance of your machine from the very beginning.

- ⊕ With this compact universal indexing head, you can clamp tools of almost any geometry and size – whether fly-mounted or between centers.
- ⊕ Combine with the spiral and relief grinding attachment for grinding cylindrical tools with spiral leads on the scale from zero to infinite.
- ⊕ Combine with the radius grinding attachment and radial adjusting device for transitionless grinding of radius and peripheral flanks in one single, continuous pass.



## ACCESSORIES

A wide range of accessories is available to you - contact us for details. On page 6 and 7 we show you what ISOG 11 accessories you will need to grind certain tools and tool shapes.

# PROPERLY THOUGHT-OUT EXTRAS

## A universal indexing head for precision at any position

Whether fly-mounted or between centers – with this compact universal indexing head, you can clamp tools of almost any geometry and size. Each of the two setting axes can be swung around by 360°, and zero positioning can be done by an unlocking 180° stop.

This universal indexing head is available with an SK40 spindle taper. The built-in dividing unit can be easily operated with one hand. A worm-gear fine setting device, by means of which you can radially adjust and exactly position the tool clamped in the indexing head, also offers special operating convenience.

## The spiral and relief grinding attachment

In combination with the universal indexing head, a spiral and relief grinding attachment transforms the longitudinal motion of the tool slide into your desired rotation. Thus, you can grind easily and precisely: faces and flanks on spiral-fluted left-hand and right-hand cutting tools, countersinks, taps, step drills and form cutters.

## Spiral leads from zero to infinite

When grinding cylindrical tools, you can set their spiral leads on the scale from zero to infinite. Any unknown spiral leads can be determined in a flash with the aid of a dial gauge.

The ISOG 11 can even perform radial relief-grinding using the wheel's circumference.

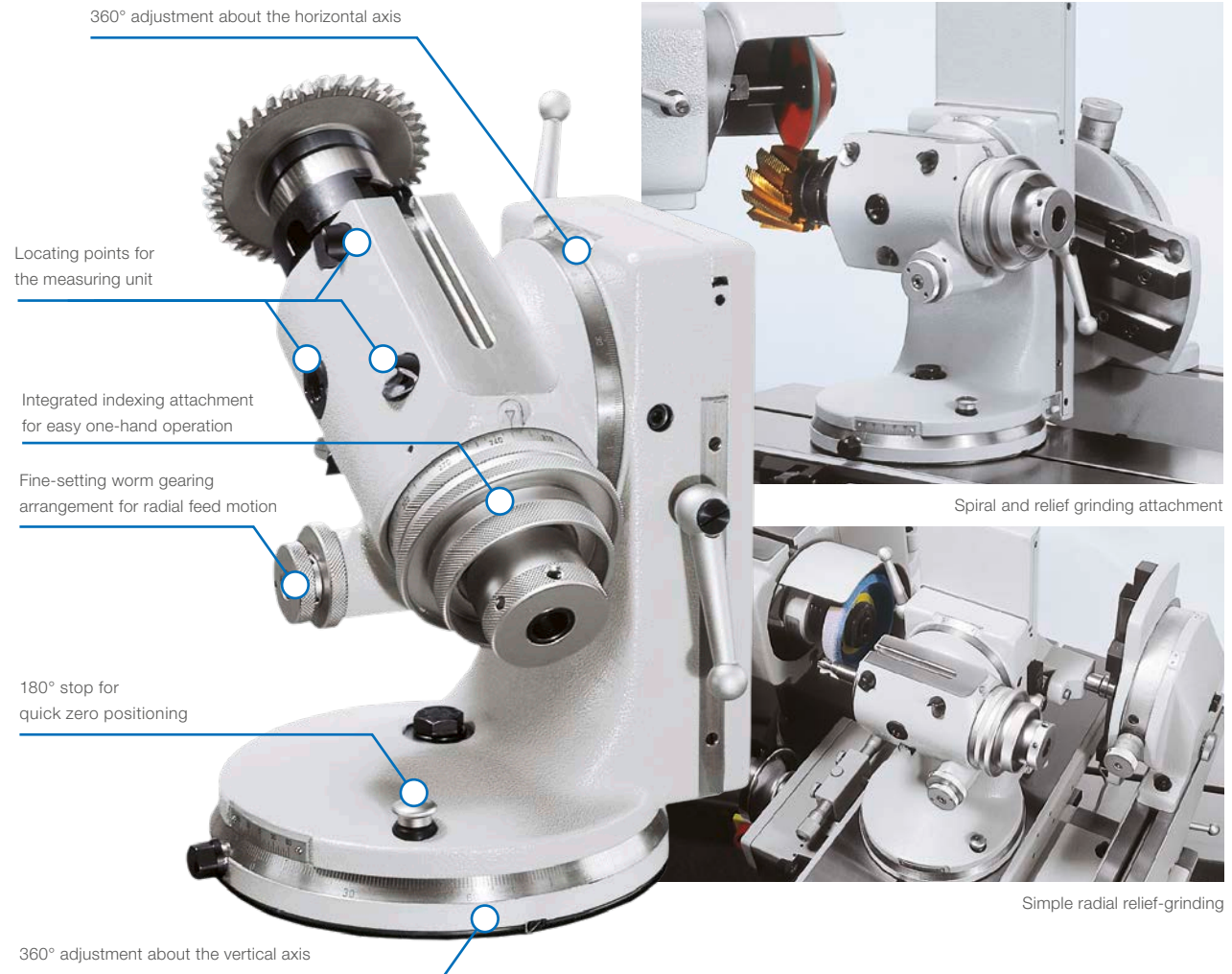

# THE RADIUS GRINDING ATTACHMENT



Radius grinding attachment



Measuring and setting gauge

**With the radius grinding attachment for the ISOG 11, you can grind perfect radii on any tools, no matter whether they are convex, concave or straight, or have straight or spiral flutes.**

Even for difficult radii such as the flutes in the radius areas of die sinking cutters or for flanks on radius tools with spiral flutes, the ISOG 11 provides proof of its really impressive strength: transitionless grinding of radius and peripheral flanks in one single, continuous pass. This unique method of comfortable radius grinding is only offered by the ISOG 11.

## **Difficult grinding problems solved without any effort**

What is new for the radius grinding attachment is a universal indexing head with its radial adjusting device and the option to directly take up an opto-electronic measuring system.







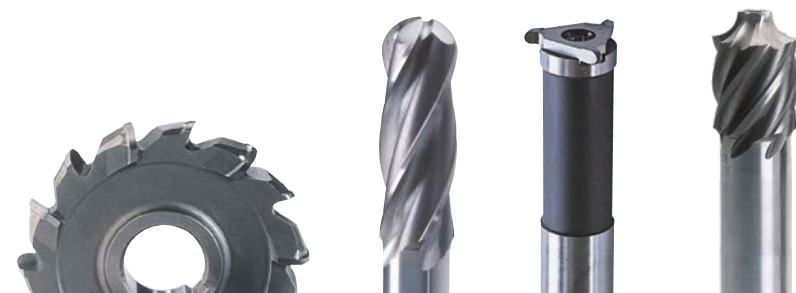

## **Trouble-free resharping**

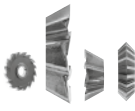
For radius tools, even resharping is not so easy. In addition to the experience of the grinding operator, a perfect result depends not least on intelligent, well thought-out machine details. In the ISOG 11 accessories offered, we, from ISOG, have implemented a lot of ideas gathered from theory and practice.

In the radius grinding attachment, you can incline the tool, precisely adjust it in a lengthwise and crosswise direction and freely swivel it, and limit the swivel angle by adjustable stops. With the aid of a measuring and setting gauge, you can position the tool into its center of rotation and exactly measure the finished tool in its clamped state.

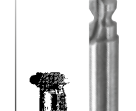

# ACCESSORIES SORTED BY APPLICATION

											
Order number	Cylindrical and taper-shank end mills, shell end mills	Side mills, T-slot cutters, single and double angle cutters	Die sinking cutters, radius cutters	Cylindrical reamers up to approx. 200 mm (8") length	Countersinks, taps	Twist drills *)	Straight-fluted multi-step counterbores	Spiral-fluted multi-step counterbores	Form turning tools	Radius turning tools	Hollow-out turning tools, form cutters (radial relief, profile relief)
<b>1</b> 2555201	X	X	X	X	X	X	X	X	X		X
<b>2</b> 2580000	X		X		X			X			X
<b>3</b> 2576000				X	X <sub>b)</sub>		X <sub>b)</sub>	X <sub>b)</sub>			
<b>4</b> 2589204											X
<b>5</b> 2617500									X	X	
<b>6</b> 2601200			X							X	
<b>7</b> 2665000	X	X	X								
<b>8</b> 2618004			X								
<b>9</b> 2570000			X				X				
<b>10</b> 2628000					X		X	X	X	X	X
<b>11</b> 2571000	X	X	X	X <sub>a)</sub>							
<b>12</b> 2575300		X									

## Legend

X – Necessary accessories

X – Accessories required to a limited extent

## Notes on the accessory items required to a limited extent

a) Not required if only bevel lead/chamfer is ground.

b) Required if tools are ground between centers or with end supported by center.

\*) Special cup grinding wheels are required for the arc-shaped point.

You haven't found your particular application yet? You are welcome to contact us and we will advise you or develop customized solutions for you!

# OVERVIEW ACCESSORIES



**1**  
**Universal index head**  
 Order no.: 2555201

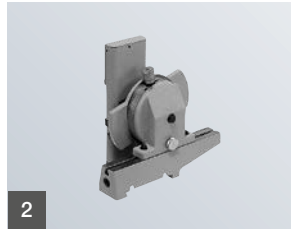

**2**  
**Spiral and relief grinding attachment**  
 Order no.: 2580000

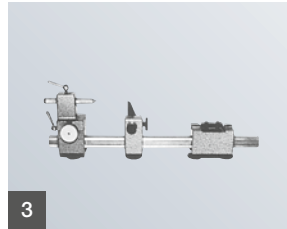

**3**  
**Support arm assembly**  
 Order no.: 2576000



**4**  
**Roller arm**  
 Order no.: 2589204



**5**  
**Tool holder**  
 Order no.: 2617500



**6**  
**Radius grinding attachment**  
 Order no.: 2601200



**7**  
**Setting gauge**  
 Order no.: 2665000



**8**  
**Support finger for radius cutters**  
 Order no.: 2618004



**9**  
**Universal setting gauge**  
 Order no.: 2570000

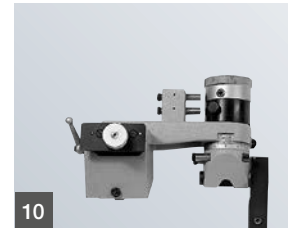

**10**  
**Universal wheel dresser**  
 Order no.: 2628000



**11**  
**Tooth rest**  
 Order no.: 2571000



**12**  
**Swivel-mounted support finger**  
 Order no.: 2575300



**Drive motor unit**  
 Order no.: 2667000

The motor drive belongs to the "universal indexing head" option and is suitable for simple cylindrical grinding work.



**Machine vice**  
 Order no.: 2635000

The machine vice is adjustable about three axes. It is used for grinding simple turning tools and for other operations.



**Opto-electronic measuring unit with video**  
 Order no.: 2684X00

Recommended for the machining of particularly precise tools. To facilitate permanent monitoring of the grinding process on the screen. Useful addition: measuring system for height and transverse movements (2683200).



**Extension for measuring unit**  
 Order no.: 2650804

The extension is part of the "opto-electronic measuring unit" and permits longer tools to be measured.

# TECHNICAL DATA

Clamping range	
Tool slide clamping surface	500 x 180 mm
Max. tool Ø between centers	130 mm
Max. tool Ø, fly-mounted on universal index head	620 mm
Max. tool length between centers	270 mm
T-slot width, machine base	12 mm
T-slot width, grinding head, tool slide and attachments	8 mm

Grinding spindle	
Three-phase AC drive motor	1.1 kW bei 2,800 min <sup>-1</sup>
Rated spindle torque	ca. 2,8 Nm
Infinitely variable spindle speeds	2,000 bis 12,000 min <sup>-1</sup>
Max. grinding wheel Ø	125 mm
Max. cut-off wheel Ø	200 mm

Dimensions	
Weight	520 kg
Dimensions (Width x Length x Height)	800 x 1,100 x 1,760 mm
Floor space (incl. operator)	2.5 x 2.3 m
Connected load	2 kVA

Adjustment ranges		
Operational	Grinding stroke	190 mm
	Grinding stroke in spiral grinding	190 mm
	Tool slide transverse travel	100 mm
	Grinding head vertical travel	325 mm
	Grinding spindle axial feed	5 mm
Coarse settings	Tool slide carrier	220 mm
	Grinding head carrier	800 mm
	Universal index head on tool slide	330 mm
Swivel angles	Grinding head carrier	360°
	Grinding head	360°
	Tool slide carrier	360°

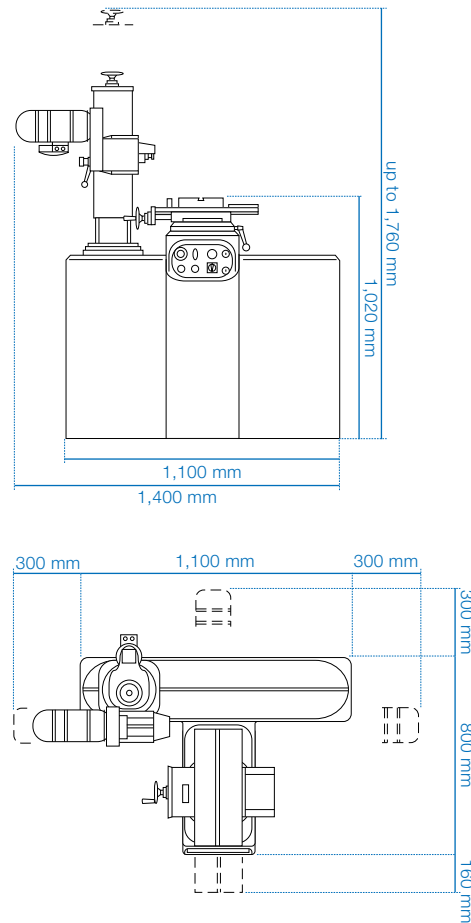

Subject to changes in the interest of technical progress and error. Illustrations and descriptions in this document contain partially paid options.

## For resharpening and manufacturing of:

End mills | drills | countersinks and counter bores | die sinking cutters | step drills | reamers | form cutters | radius tools | special drills | boring tools | shell end mills | taps and many other tools

## Contact us:

Phone (USA): +1-224-659-7101

Phone (Germany): +49 6073 14 275

isog@elb-schliff.de

www.isog-technology.com