

ISO G 24



Outside overview

INSIDE OVERVIEW



TECHNICAL DATA



Automation (optional)
by a practical modular construction system: chain loader KL105, KL315 or robot loading system

Storage and storage possibilities
integrated storage table and folding compartments for accessories

Connection
for cleaning pistol

Innovative extraction system
with downward-directed airflow

Control
NUM Flexium+ and B&R control

Software
NUMROTOplus®

Control panel
with 21.5" touch screen, ergonomic mouse and RFID interface

Cast mineral machine stand
made of polymer concrete

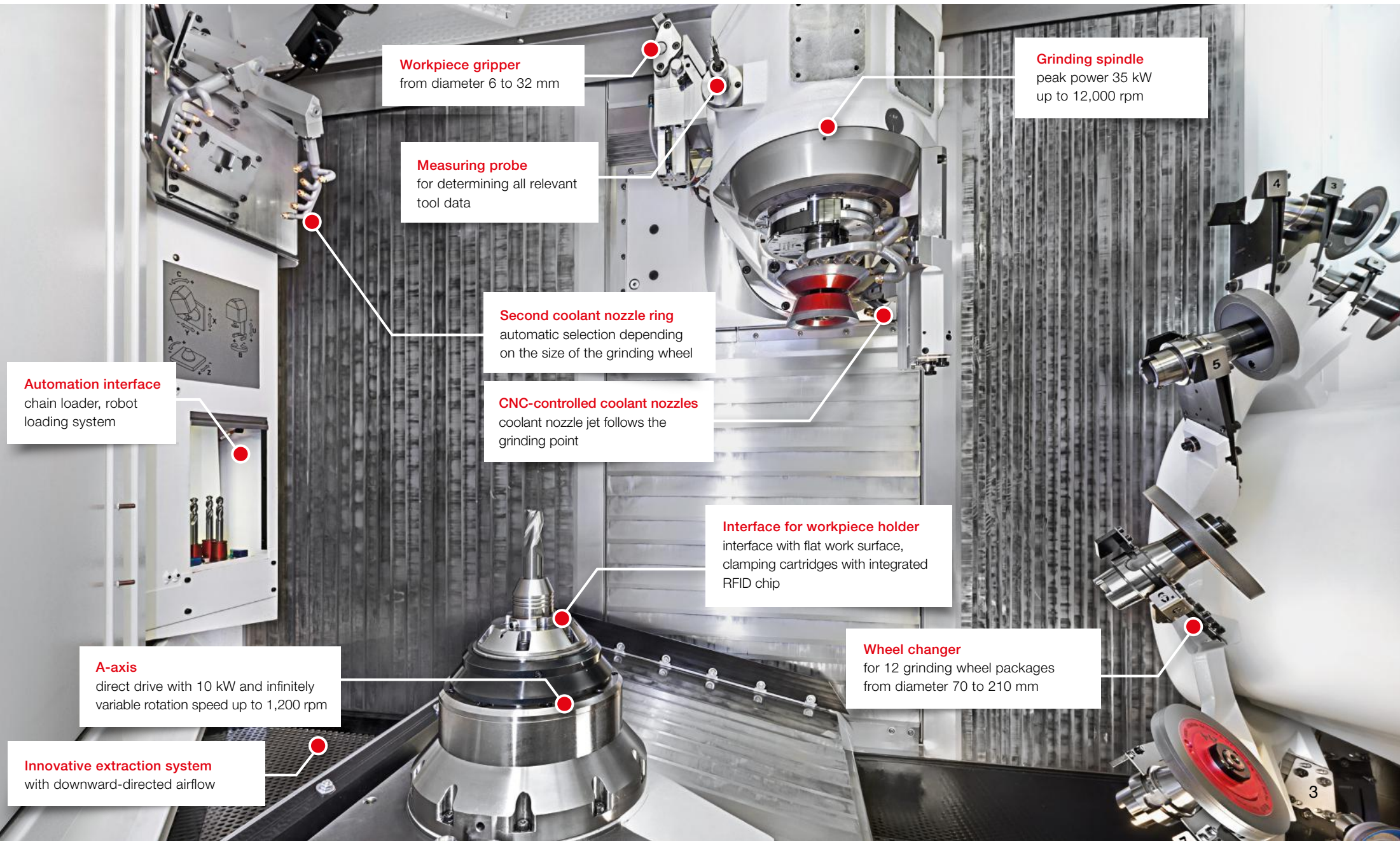

Workpiece gripper
from diameter 6 to 32 mm

Measuring probe
for determining all relevant
tool data

Second coolant nozzle ring
automatic selection depending
on the size of the grinding wheel

CNC-controlled coolant nozzles
coolant nozzle jet follows the
grinding point

Interface for workpiece holder
interface with flat work surface,
clamping cartridges with integrated
RFID chip

Grinding spindle
peak power 35 kW
up to 12,000 rpm

Automation interface
chain loader, robot
loading system

A-axis
direct drive with 10 kW and infinitely
variable rotation speed up to 1,200 rpm

Innovative extraction system
with downward-directed airflow

Wheel changer
for 12 grinding wheel packages
from diameter 70 to 210 mm

CNC-controlled coolant nozzles

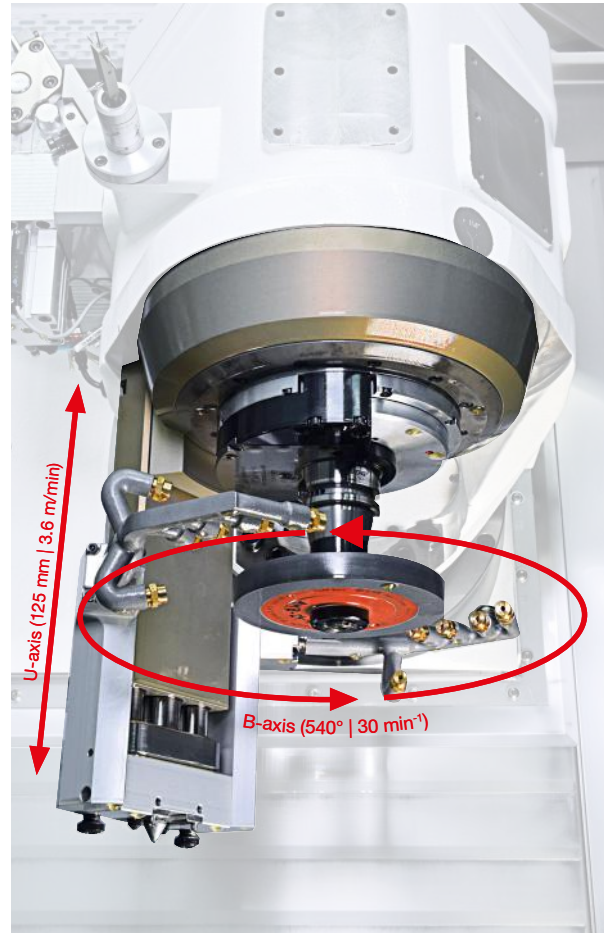
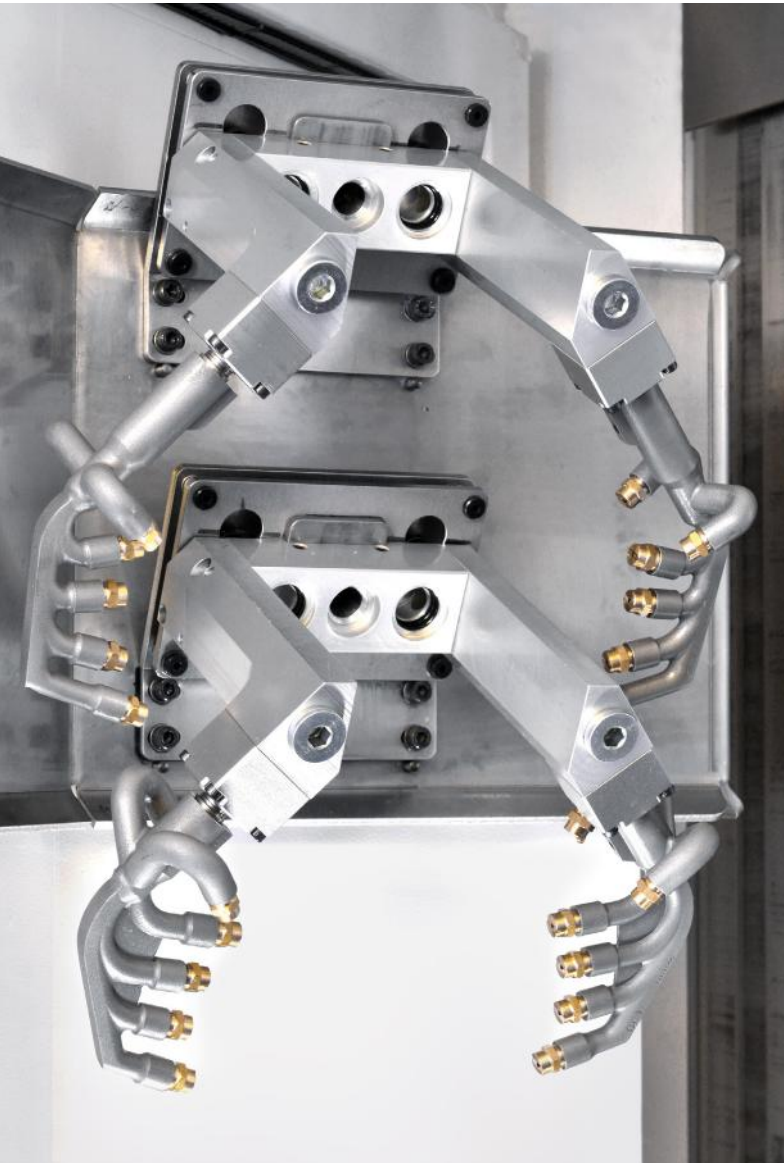

Two for all

The new system is designed for grinding wheels between diameter 70 and 210 mm. Using two coolant nozzle rings, which can be exchanged automatically or manually as needed: Ring 1 is for wheels up to 150 mm diameter, ring 2 is for 125 to 210 mm diameter.

Efficient cooling

The coolant nozzles of the ISOG 24 move with the grinding point along the grinding wheel, automatically controlled by software. This creates efficiency: Coolant consumption is reduced by up to 80 percent. The grinding results are better – still the grinding is faster and more productive. The new, intelligent coolant nozzles sit in the shape of a rim directly on the grinding head.

Operations become easier

The new cooling system from ISOG does not need any set-up time and is very flexible because the cooling is no longer manually set up or optimised. An optimised coolant position is already stored during programming – it can also be fine-tuned manually if necessary.

- ⊕ significantly lower acquisition costs due to the universal coolant rings
- ⊕ new coolant nozzles save time and money: shorter set-up times, better grinding performance
- ⊕ better grinding results
- ⊕ less grinding wheel wear
- ⊕ measurably better surface quality
- ⊕ comfortable setting up and adjustment of the coolant nozzles by software
- ⊕ coolant consumption drops by up to 80 percent

Extraction system

BACK TO OVERVIEW | [INSIDE](#)



[OUTSIDE](#)

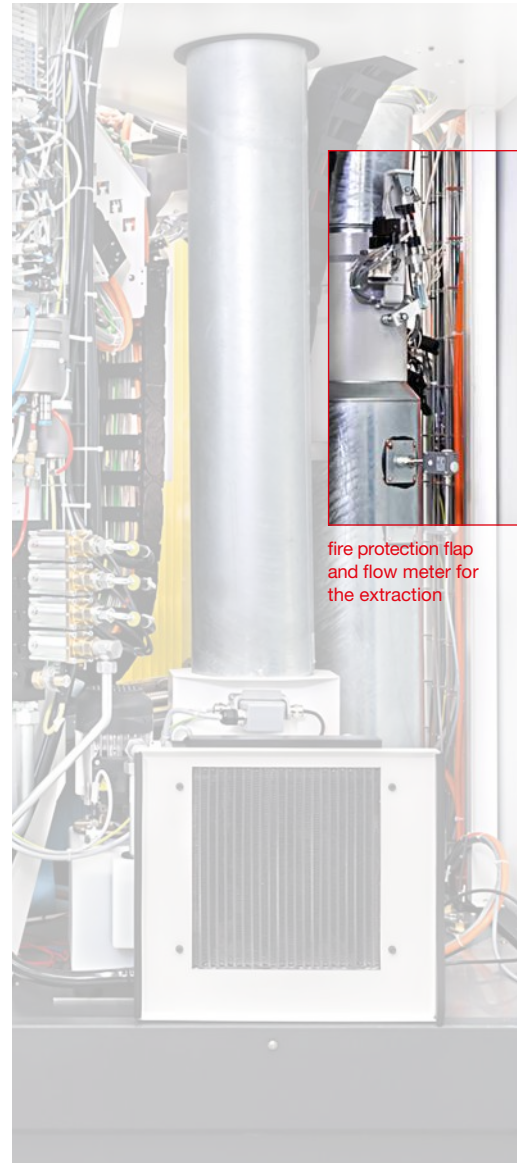

fire protection flap
and flow meter for
the extraction

Airflow follows gravity

The ISOG 24 is breaking new ground here: For the first time, the airflow is directed downwards – physically convincing, as gravity goes in the same direction. Thanks to the controlled airflow, there is less fogging, which gives the operator a much better view of the grinding process. The supply air flows into the machine through a long opening at the top of the cabin. The airflows are smooth and straight, with low flow velocity.

The airflow and the extraction are continuously monitored in real time and the real values are displayed in the machine data. These are compared with the minimum and maximum specifications of ISOG and displayed to the operator on the screen via a message as soon as the limit range has been reached. In addition, the exhaust air system has a fire protection flap as standard.

-
- ⊕ ISOG uses gravity
 - ⊕ significantly better view
 - ⊕ no swirls and turbulence
 - ⊕ no flow noises



Maximum working sizes



Power meets flexibility

The A-axis is infinitely variable and has been designed for a maximum rotation speed of 1,200 rpm. The electric direct drive has a torque of 63 Nm and a power of 10 kW at 410 rpm.

The interface for the clamping systems has been defined with a flat work surface in such a way that a quick and easy change of the clamping systems is possible.

- + new interface for quick and easy change of clamping systems
- + infinitely variable rotation speed, maximum 1,200 rpm
- + electric direct drive



twisted step drill



profile tool



spade drill

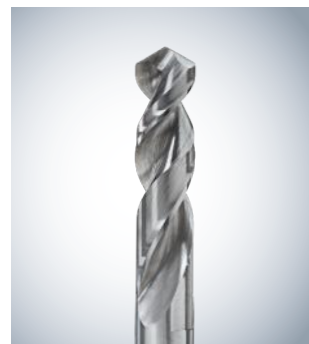

twist drill with differential twist

Clamping systems



cartridge with HSK interface



hydraulic clamping cartridge
diameter 32 mm



cartridge for collets



cartridge with Capto interface



Integrated chip provides data
ISOG integrates an RFID chip into each clamping cartridge. Thus, the respective clamping system can be automatically identified during insertion. With the help of the chip the clamping cycles are continuously recorded, which enables preventive maintenance.



hydraulic clamping cartridge diameter 20 mm

Change in a few minutes

Thanks to the adaptive A-axis, the clamping system can be changed within a few minutes. For this purpose, clamping cartridges are used, which are configured as required. Changing the pre-assembled clamping cartridges is fast on any day.

Free choice of systems

Customers are completely free to choose their systems. The clamping forces are generated by spring packages of the clamping cartridge, which ensures that the workpiece is held securely even in an energy-free state. Monitoring of the clamping state is integrated in the A-axis.

- ⊕ convenient change of the clamping systems
- ⊕ automatic recording of clamping cycles on the RFID chip during clamping system change
- ⊕ automatic clamping system detection
- ⊕ predictable and preventive maintenance through accurate clamping cycle detection
- ⊕ new clamping system interface opening up a wide range of processing options

12-fold wheel changer

Large selection, small expenditure of time

Twelve grinding wheel packages with HSK A50 holder are ready for use at any time. Twelve positions are designed for grinding wheels up to a diameter of 125 mm, three of the positions can also be used for grinding wheels up to 210 mm. The machine is thus extremely flexible: Tools and parts can be manufactured and sharpened in just one single clamping.

Within 14 seconds, the ISOG 24 changes the grinding-wheel packages, whereby, workpiece for workpiece, valuable time can be gained.

The ISOG 24 achieves an unusually high repeatability of the tools and parts. This is ensured by two details: the exact stop of the grinding spindle and the anti-twist device of the wheel mounts in the magazine brackets.

- ⊕ extremely flexible because a wide variety of parts can be processed in one tension
- ⊕ grinding wheel change in only 14 seconds
- ⊕ highest precision and repeatability
- ⊕ low space requirement, since the coolant nozzles are not changed as well

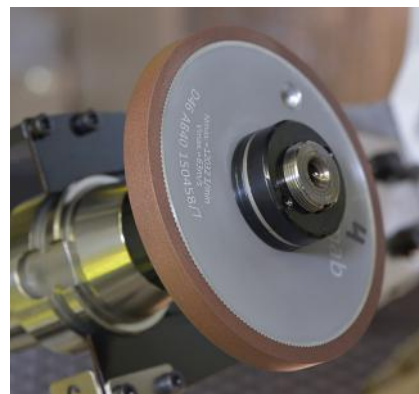
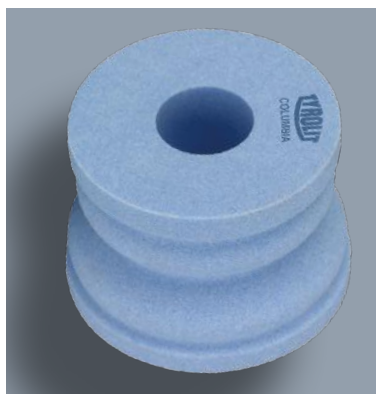
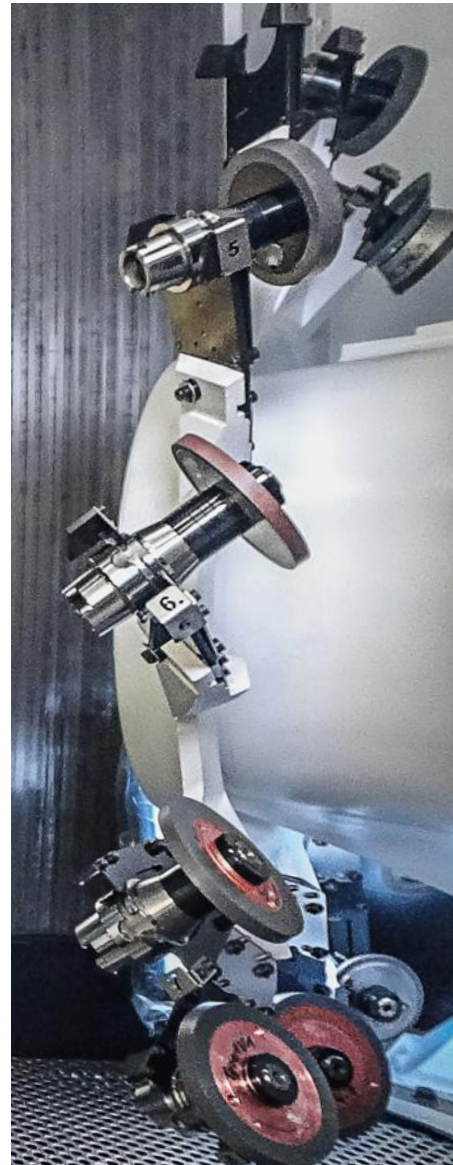
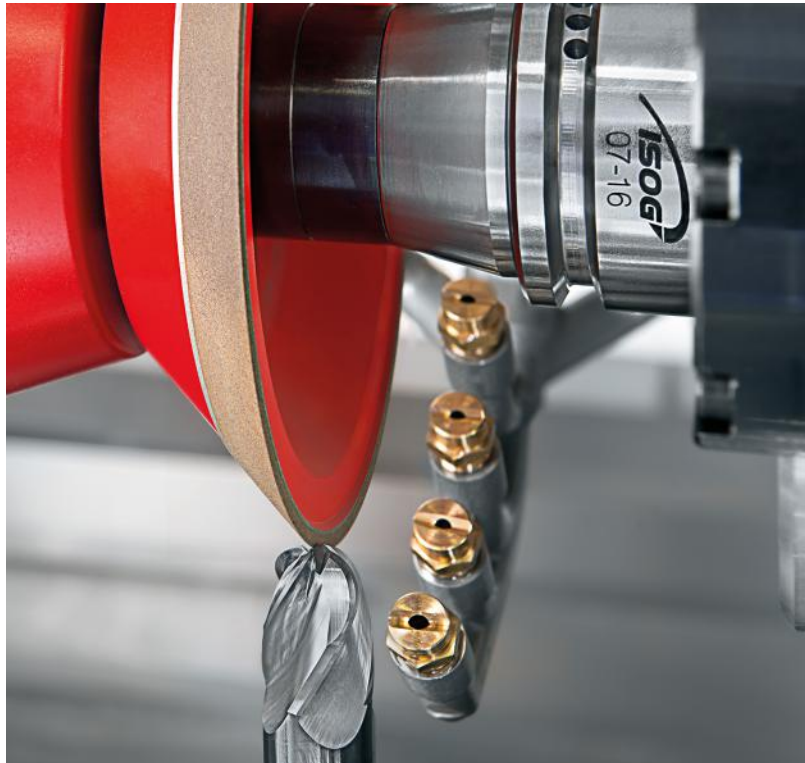

Automation (optional)

Automation as needed

The ISOG 24 is available with different automation solutions, all of which can be adapted to a dedicated interface. There is a choice of chain loaders with 105 and 315 places as well as a robot cell. The chain loaders are flanged to the machine as a module to save space. All automation solutions can also be loaded and unloaded during operation. Accessories required for this can be easily accommodated on the storage table as well as in the integrated folding compartments. These can be individually positioned. The entire equipping of the chain loader can be viewed from the outside through viewing windows.

The modular system

The conversion or retrofitting is easily possible thanks to the modular system of the ISOG 24. This not only saves time, but also money. The open interface allows to work together with all current providers of automation solutions.

- ⊕ loading /unloading during the grinding process
- ⊕ flexible and interchangeable automation
- ⊕ large machine access, so that even large components can be loaded and processed



ISOG 24 with chain loader KL105

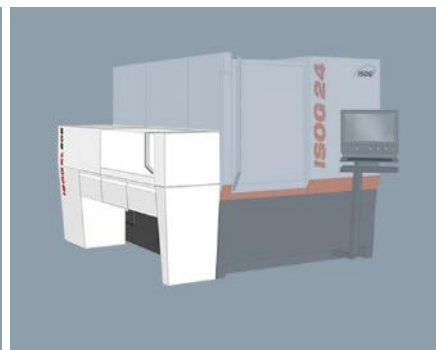

ISOG 24 with chain loader KL315



ISOG 24 with robot cell

Grinding spindle & gripper

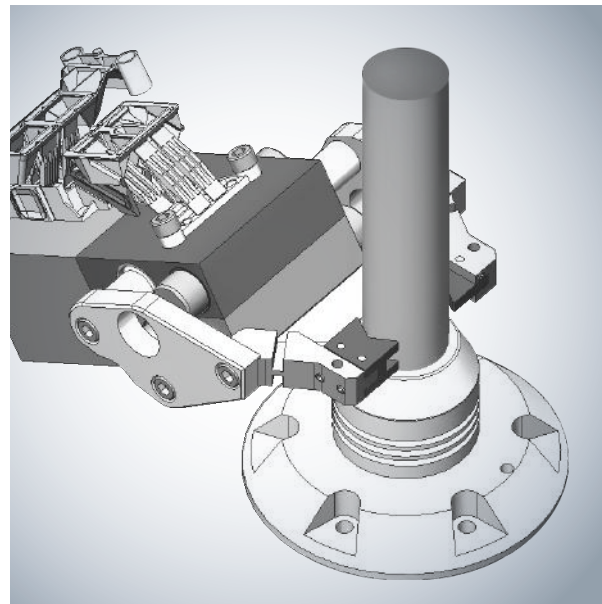
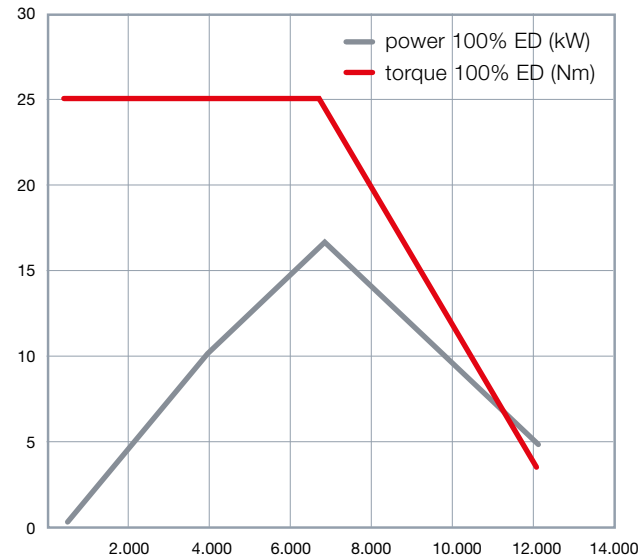
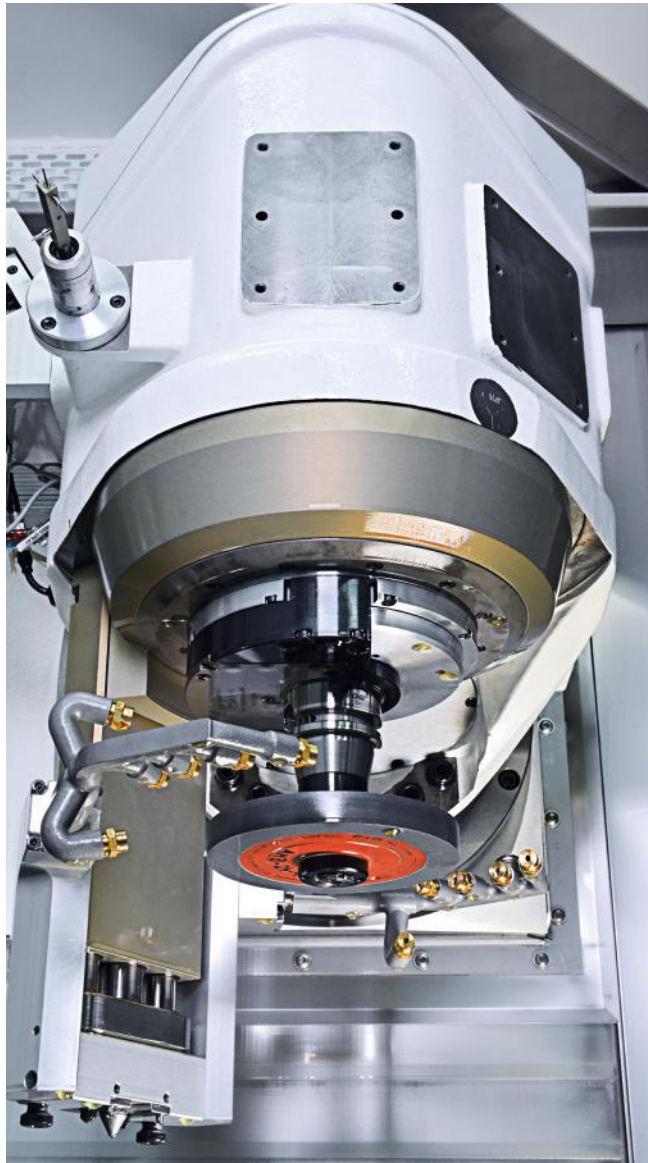

Strong and fast

Grinding spindle

The direct grinding spindle drive has a peak power of up to 35 kW. Linear and rotary axes are driven directly.

The tool gripper

The universal tool gripper is available with two different prism sizes: with a carbide prism for diameter 3 to 16 mm and a standard carbide prism for diameter 6 to 32 mm. The additional grippers for the automatic bushing change can be mounted for a chaotic loading of different shank diameters.

The entire tool gripper of the ISOG 24 is particularly fast in terms of setting and adjustment.

- ⊕ powerful grinding spindle with up to 12,000 rpm and a peak power of 35 kW
- ⊕ higher productivity and shorter processing times through the combination of coolant nozzle and grinding spindle
- ⊕ universal tool gripper for a diameter range from 6 to 32 mm without prism change
- ⊕ highest concentricity because μ -exact loading is achieved via the CNC axes
- ⊕ higher flexibility due to chaotic loading

Precision at the touch of a button

The tool probe of the ISOG 24 can be used in many different ways. In conjunction with NUMROTOplus® it allows to record all relevant tool data. Ground values can thus be controlled directly in the machine and be compensated immediately if necessary.

Second measuring probe for grinding wheel data

The second measuring probe is useful in many respects. In conjunction with dressing and regeneration of grinding wheels, it allows to machine even large batch sizes fully automatically. The basic dimensions of the grinding wheel can be determined.

-
- ⊕ precise and fast determination of tool data
 - ⊕ compensation during machining of important tool dimensions
 - ⊕ capturing of all important and possible tool data
 - ⊕ measuring of grinding wheels in the machine



Control panel

BACK TO OVERVIEW | INSIDE



OUTSIDE

Clear and functional

Multifunctional control panel

The large, high-resolution 21.5" flat screen is very comfortable for the operator, especially when programming on the machine. The powerful machine computer allows fastest simulations in high resolution quality. All specifications for a screen workstation are met.

The control panel includes an ergonomic, space-saving trackball mouse and a half-stop keyboard. So the desk looks very tidy. And it's designed for durability, as all components are oil resistant.

The ISOG 24 also offers a service mode. This is secured via a registration via RFID chip.

- ⊕ large screen for programming work
- ⊕ oil resistant mouse and keyboard
- ⊕ integrated storage compartment
- ⊕ compressed air connection with bracket
- ⊕ service mode





NUM Flexium⁺

The scalable, modern control NUM Flexium⁺ controls all CNC axes and the grinding spindle of ISOG 24. With the built-in drives and motors from NUM as well as the comprehensive NUMSafe safety concept for hard and software, the ISOG 24 fulfils all the important standards for safety-related motion functions.

- complete, digital system (CNC, drives, motors)
- open and powerful system – allows optimal adaptation to customer needs
- internal control position calculation in the sub-nano range for high accuracy and protruding surfaces
- fast data interface (TCP/IP) for probe and grinding data
- integrated, comprehensive security management (EN ISO 13849-1 and EN 61800-5-2)
- worldwide service and customer support



B&R-control

The second control is from B&R. It works hand in hand with the NUM control. This allows the ISOG 24 to cleanly separate between machine axes on the one hand and the peripheral components on the other, which include loading modules, centralised oil lubrication, grinder exchangers, fire extinguishing systems, suction and many other elements.

This makes the ISOG 24 open to countless solutions available on the market, as the most common interfaces are very compatible.



NUMROTOplus[®]

- extensive software for almost every grinding task
- exact and fast 2D-section simulation in any position
- 3D-simulation with automatic Collision check and QW analysis
- help images for almost every input value
- flexible, logical and user-friendly programming
- probing and compensating of concentricity errors
- job manager for the unmanned operation, even with measuring in the process
- continuous development and investment protection
- regular program updates and extensions with full compatibility



Optimised for Condition Monitoring

The ISOG 24 is optimally prepared for digital developments because the next steps have already been taken into consideration in its development. It is completely networkable and, thanks to its sensors, software and interfaces, optimally equipped for permanent condition monitoring, preventive maintenance and long-term diagnostics.

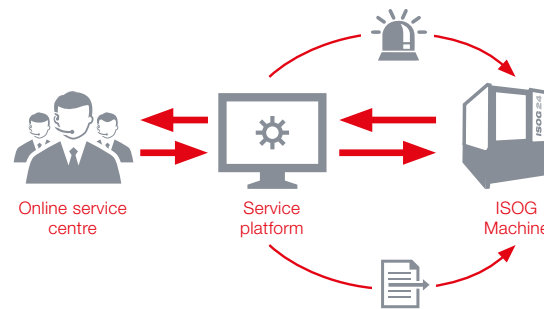

- ⊕ condition monitoring increases efficiency and ensures safety and reliability in operation
- ⊕ evaluation of the machine data by ISOG experts brings additional benefits
- ⊕ preventive maintenance
- ⊕ no unplanned repairs

Optimised for service work

When designing the ISOG 24, attention was paid to access to the machine for service work. Two large service accesses have been created on the right side. The interior rear is much more accessible. The optimizations not only benefit local ISOG technicians, but also all those companies who carry out certain maintenance work on their machines themselves.

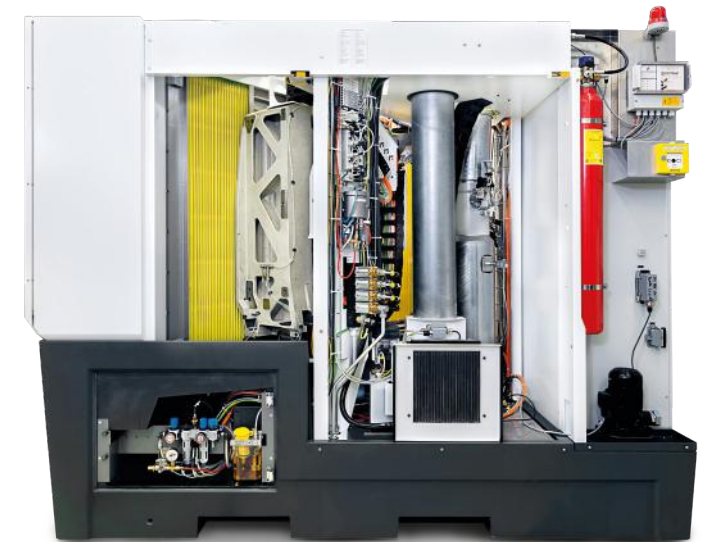



Commissioning

During commissioning, we examine all functions in great detail and, if necessary, make integration tests for options and accessories. We train and instruct your operating personnel individually and in detail. If required, we grind a workpiece you have defined.



Training

We offer individually designed customer training that we can carry out at your production site and on your machine. Our course categories range from general grinding to operation and programming through to special courses.



Updates

At our production site, we maintain our own overhaul department with experienced employees. We will gladly advise you on site about overhauling your machine and carry out an inventory.



On-site Service

Our qualified service technicians are stationed worldwide and, if required, quickly with you. They identify faults, repair, measure, assess and restore, if necessary, the machine geometry and take stock.



Online Service

A team of six works in our online service center. The experts are happy to assist you by phone. We also offer help at the touch of a button. For this we connect your equipment to the Internet and establish an online connection between your machine and our service center. That's secure, because we use the protected online connection solution VPN. The access allows us to quickly analyse the situation and diagnose malfunctions. Together, we find solutions. To ensure that the connection works immediately, we check the signal quality during regular connection checks if necessary. You benefit from our online machine documentation and also from our diagnostic and reporting tools.



Maintenance

We carry out maintenance systematically by means of a detailed checklist with machine-specific work steps and inspection points. You choose between recurring maintenance (possible interval: 12 months) and a one-time maintenance.



Technical data

Control

type	NUM Flexium+ and B&R control
operating system	Windows 10

Clamping and grinding range

max. workpiece diameter ¹⁾	250 mm
max. workpiece length ²⁾	470 mm
max. workpiece length face grinding ³⁾	350 mm
max. workpiece weight ⁴⁾	50 kg

Wheel changer

drive	electric direct
number of places	12
max. package weight	4 kg
max. grinding wheel diameter	210 mm

Grinding spindle

drive motor	direct synchronous
rated power	17 kW at 100% ED
peak power ⁵⁾	35 kW
cooling medium	oil
rotation speed	1,000 - 12,000 rpm – right / left
torque	24 Nm to 6,000 rpm at 34 A

Dimensions

weight	7,100 kg
dimensions	2,840 x 2,000 x 2,200 mm

Automation (optional)

Chain loader

drive	electric direct
controlled axes	1
max. workpiece dimension	ø 32 x 180 mm
max. workpiece weight	1.5 kg
magazine places (chain)	105
dimensions	200 x 2,650 x 1,150 mm
weight	180 kg

Movement range / measuring system

X-axis	traversing range	600 mm
	feed rate	24 m/min
	drive	electric direct
	measuring system	direct absolute
Y-axis	traversing range	1,100 mm
	feed rate	30 m/min
	drive	electric direct
	measuring system	direct absolute
Z-axis	traversing range	410 mm
	feed rate	30 m/min
	drive	electric direct
	measuring system	direct absolute
A-axis	rotation range	continuous
	feed rate	1,200 rpm
	drive	electrically direct, torque
	measuring system	direct absolute
C-axis	rotation range	234°
	feed rate	60 min ⁻¹
	drive	electric direct, torque
	measuring system	direct absolute
C-axis	rotation range	234°
	feed rate	60 min ⁻¹
	drive	electric direct, torque
	measuring system	direct absolute
C-axis	rotation range	234°
	feed rate	60 min ⁻¹
	drive	electric direct, torque
	measuring system	direct absolute

Movement range / coolant nozzles

B-axis	pivoting range	540°
	feed rate	30 min ⁻¹
	drive	electric direct
	measuring system	indirectly absolute
U-axis	traversing path	125 mm
	feed rate	3.60 m/min
	drive	electric direct
	measuring system	indirect absolute
U-axis	rotation range	10°
	resolution	10°

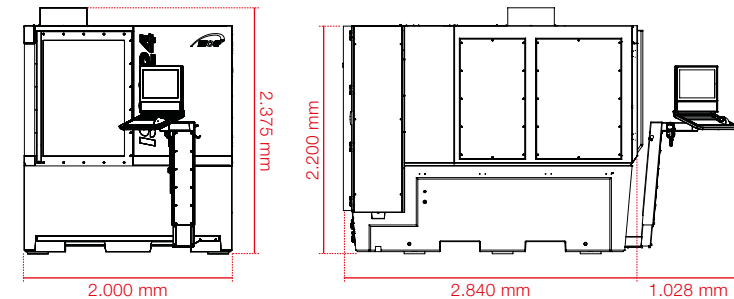

Explanations:

- 1) depending on the tool type
- 2) max. clamping length from upper edge of tapered sleeve
- 3) depending on workpiece position, wheel mount and grinding task
- 4) depending on the moment of inertia
- 5) up to 30 seconds

Subject to changes in the interest of technical progress and error. Illustrations and descriptions in this document contain partially paid options.

